

TSUBAKI FLATVEYOR ZP Type

Hose and Cable Carrier System

FLATVEYOR



Freestanding flat cable system with an openable structure

Tsubaki **FLATVEYOR** ZP Type



Freestanding function added

The support member reduces sag in the unsupported length section and allows the cable/tube to stand on its own. It also suppresses bouncing during operation.

Sag comparison

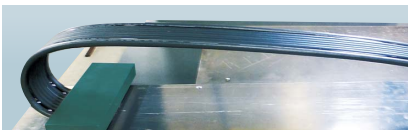

Flatveyor (Tsubaki)

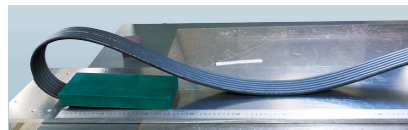

Flat cable (competitor)

Bounce comparison



Flatveyor (Tsubaki)

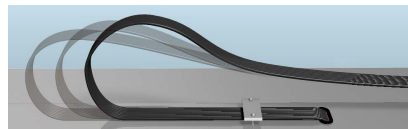

Flat cable (competitor)

Using Tsubaki's **original design** openable tube

Tsubaki has developed an original openable tube that features excellent flexibility, durability, and slidability. The locking part is easy to open and close and has a zipper structure that does not open during operation.



Low debris generation and low noise

Integrated support member structure reduces generation of wear debris. An original short pitch structure and the sound insulation effect of the integrated support member tubes reduce noise.

Clean class equivalent to ISO class 2 ^{Note}

Note: Based on in-house test results in accordance with ISO 14644-1 "Classification of air cleanliness by particle concentration."

Available in **two colors**

Products are available in black or white.



Black

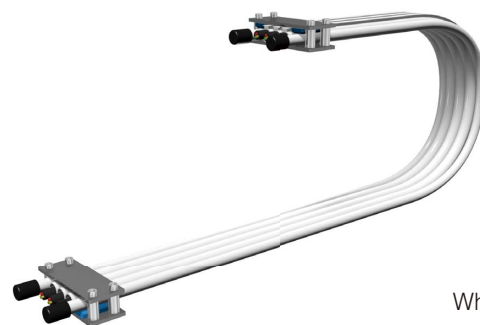

White

Note: The caps for white are black.

Easy Handling

Cables and tubes can be installed and replaced



Cables and tubes can be installed and replaced by opening and closing the locking part.

- Easy to change cable and tube designs
- Easily replace only failed cables
- Contributes to SDGs by eliminating entire replacement required by flat cables

Easy installation and removal of cables and tubes

No screwdriver or hammer is needed to open and close the openable tube.

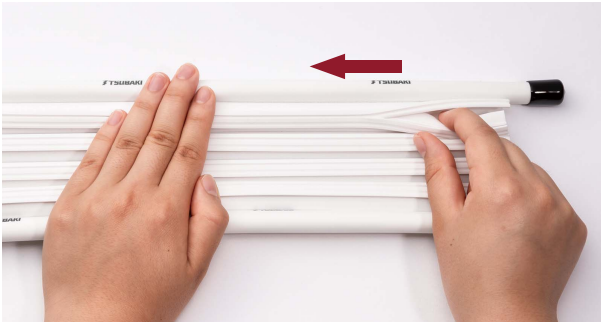

Easy to open by hand

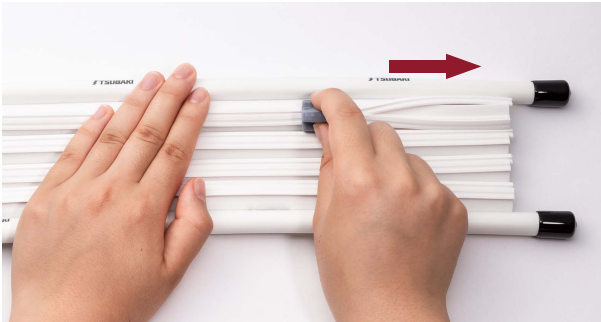

Easy to close using the original closing tool
(Also closable by hand)

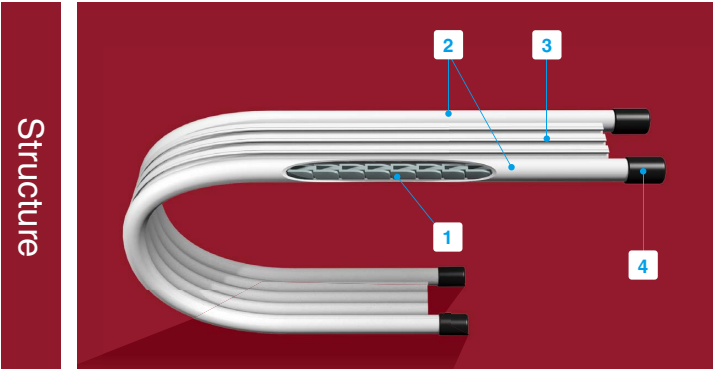

Structure

Part name	1 Support member
Function	This supports the cable/tube and reduces sag. Like cable carriers, it also maintains the bending radius. This is integrated in support member tubes and assembled on both sides.
Material	Engineering plastic

Advantages

Reduces labor for installation

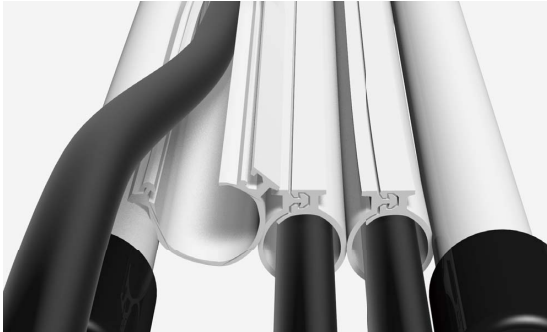

Openable tubes create independent installation spaces.

- No need to divide cables and tubes

Improved yield

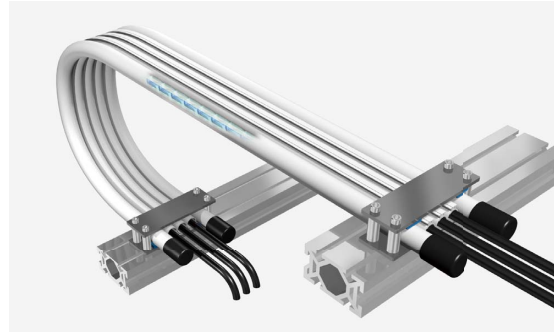

Excellent slidability and sealed structure is equivalent to ISO cleanroom class 2.

- Effective for debris generation control (low debris generation)

Selectable colors

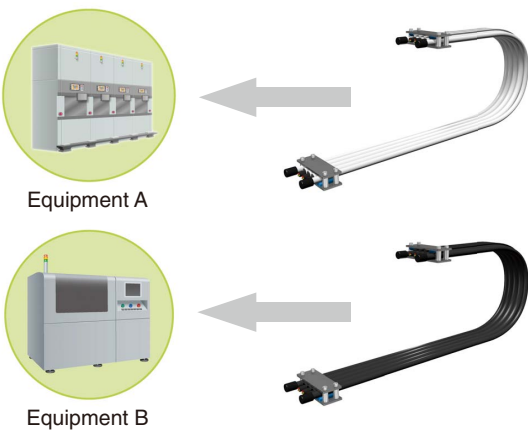

Black or white can be selected to match the equipment and operating environment.

Prevents equipment stoppage risks

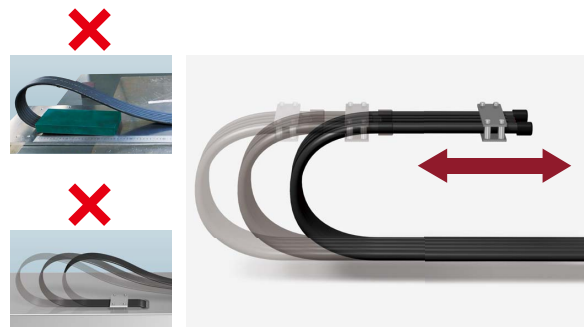

Maintaining the bending radius supports and guides the cables/tubes to keep to the track.

- Reduced risk of failed cable

2 Support member tube

This tube stores the support member. Integrated support member structure reduces generation of wear debris.

PVC

3 Openable tube

This tube stores a cable or tube. Up to eight tubes can be selected. Each openable tube is welded together.

PVC

4 Cap

This prevents the support member from slipping out. It is welded to both ends of the support member tube.

PVC

Basic specifications

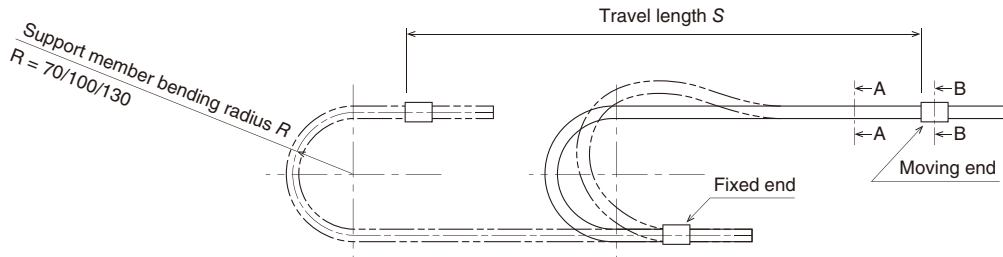

Support member bending radius R mm	Support member pitch P mm	Maximum travel length S mm	Maximum travel speed m/s	Maximum acceleration G	Operating temperature range $^{\circ}C$	Maximum cable/tube outer diameter mm
70	20	1600	2	2	-10 to 60	11 or less
100	26	1800				
130	26	1800				

Notes: 1. The elasticity of the cable/tube inside the openable tube may cause the bending radius of Flatveyor to be larger than the support member bending radius. Because the characteristics will vary by manufacturer, contact your cable/tube manufacturer for further information.
 2. The maximum travel length varies depending on the weight of the cable/tube to be installed in the openable tube. For details, refer to the load diagrams on pages 11–12.

Cross-section dimensions (Basic specification: A-A arrow view)

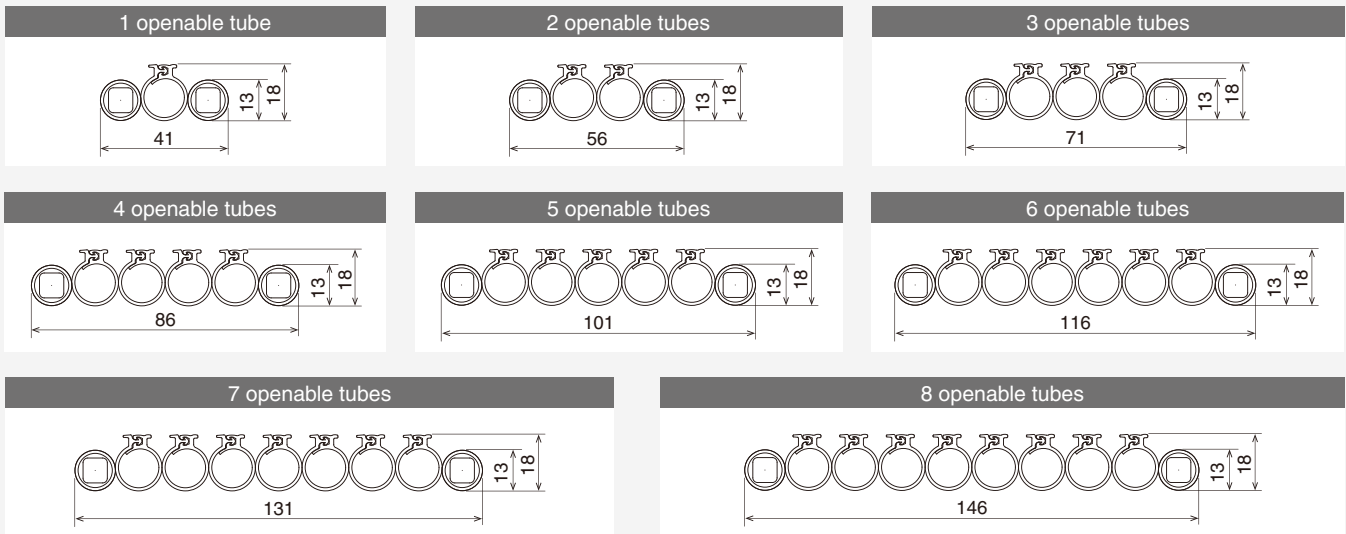

Number of cables (jackets) and tubes to be installed and recommended materials

- Refer to the table below for the number of installable cables and tubes.
- The materials in the following table are recommended for the cables and tubes. Contact Tsubaki representative if you use materials other than those recommended.

Installable quantity		
1	2 ^{Note 1, 2}	3 ^{Note 2}
$\phi 11$ or less	13 mm or less in width when placed side by side	Outer diameter of each cable/tube is 4 mm or less

Type	Recommended material
Cable (jacket)	Low-friction smooth PVC
Tube	Low-friction smooth PUR (Polyurethane)

Notes: 1. The difference in outer diameters of adjacent cables/tubes should be 5 mm or less.
 2. Passing over and entanglement of cables/tubes may lead to premature breakage. It is recommended that each cable or tube be installed in a single openable tube.

Fixing parts (Basic specification: B-B arrow view)

Clamps, fixed pieces for support member, and spacers are required to secure the Flatveyor ZP type. These are not supplied with the product, so prepare them by referring to the recommended dimensions below. Tsubaki can also manufacture them for you.

Type	Clamp ^{Note}	Fixed pieces for support member	Spacer
Recommended material	Stainless steel	Aluminum or rigid plastic	–
Required quantity	1 each for fixed end and moving end	2 each for fixed end and moving end	4 each for fixed end and moving end

Note: Tighten the clamps in four positions using M6 bolts.
The bolts to fix the clamps in place must be prepared separately.

Installation dimensions

Openable tube quantity	Required space (Width) ^{Note 1} mm	Required space (Height) mm	Mounting height H' mm		
			Support member bending radius		
			R070	R100	R130
1	146	Mounting height + 100	223 to 243	283 to 303	343 to 363
2	166				
3	186				
4	206				
5	226				
6	246				
7	266				
8	286				

Notes: 1. Openable tubes and support member tubes are deformed into an oval shape at bends and other sections, resulting in dimensional changes in the width direction.
2. The clamping position on the fixed end side should be 5 mm from the end face of the shortest openable tube.

Manufacturing label
See page 8 for the information contained in the manufacturing label.

Closing tool



Model number

FVZP-D13-AST

Note: The closing tool is not supplied with the product.
Please order it separately.

Model Numbering and Ordering Information

FLATVEYOR ZP type model number example

Product name

FVZP **20** **D13** **N06** **SM2** **R070** **C1**
+ **42L**

(1) (2) (3) (4) (5) (6) (7) (8)

(1)	Product series code	Flatveyor ZP type
(2)	Support member pitch	Pitch per link ^{Note 1}
(3)	Openable tube inner diameter	Inner diameter of the openable tube
(4)	Openable tube quantity	Number of openable tubes <ul style="list-style-type: none"> ▪ Up to eight tubes can be selected ▪ This number is expressed by two digits (N01 to N08)
(5)	Support member quantity	Number of support members as a standard quantity <ul style="list-style-type: none"> ▪ SM2 only
(6)	Support member bending radius	Bending radius of the support member <ul style="list-style-type: none"> ▪ Dimensions are expressed by three digits (R070, R100, R130)
(7)	Color	Color for the Flatveyor ZP type <ul style="list-style-type: none"> ▪ C1: black C2: white
(8)	Support member link quantity	Number of links per support member ^{Note 2}

Notes: 1. Specified by the support member bending radius.
 2. Calculated in Step 5 on page 10.

Product lineup



Black

Openable tube quantity	Support member bending radius	70 mm	100 mm	130 mm
	1		FVZP20D13N01SM2R070C1	FVZP26D13N01SM2R100C1
2		FVZP20D13N02SM2R070C1	FVZP26D13N02SM2R100C1	FVZP26D13N02SM2R130C1
3		FVZP20D13N03SM2R070C1	FVZP26D13N03SM2R100C1	FVZP26D13N03SM2R130C1
4		FVZP20D13N04SM2R070C1	FVZP26D13N04SM2R100C1	FVZP26D13N04SM2R130C1
5		FVZP20D13N05SM2R070C1	FVZP26D13N05SM2R100C1	FVZP26D13N05SM2R130C1
6		FVZP20D13N06SM2R070C1	FVZP26D13N06SM2R100C1	FVZP26D13N06SM2R130C1
7		FVZP20D13N07SM2R070C1	FVZP26D13N07SM2R100C1	FVZP26D13N07SM2R130C1
8		FVZP20D13N08SM2R070C1	FVZP26D13N08SM2R100C1	FVZP26D13N08SM2R130C1



White

Openable tube quantity	Support member bending radius	70 mm	100 mm	130 mm
	1		FVZP20D13N01SM2R070C2	FVZP26D13N01SM2R100C2
2		FVZP20D13N02SM2R070C2	FVZP26D13N02SM2R100C2	FVZP26D13N02SM2R130C2
3		FVZP20D13N03SM2R070C2	FVZP26D13N03SM2R100C2	FVZP26D13N03SM2R130C2
4		FVZP20D13N04SM2R070C2	FVZP26D13N04SM2R100C2	FVZP26D13N04SM2R130C2
5		FVZP20D13N05SM2R070C2	FVZP26D13N05SM2R100C2	FVZP26D13N05SM2R130C2
6		FVZP20D13N06SM2R070C2	FVZP26D13N06SM2R100C2	FVZP26D13N06SM2R130C2
7		FVZP20D13N07SM2R070C2	FVZP26D13N07SM2R100C2	FVZP26D13N07SM2R130C2
8		FVZP20D13N08SM2R070C2	FVZP26D13N08SM2R100C2	FVZP26D13N08SM2R130C2

Accessory model number

Product name	Model number
Closing tool	FVZP-D13-AST

Ordering example

Example of order for two FVZP20D13N04SM2R070C1 having 50 links and one closing tool.

	Model number	Quantity	Unit
Flatveyor	FVZP20D13N04SM2R070C1+50L	2	SET
Closing tool	FVZP-D13-AST	1	PC

Manufacturing label Information



Manufacturing label layout

Support member bending radius/Number of links
Tsubaki manufacturing number

Manufacturing information example

R070/50L
WTA2N015-15

Step 1 Determination of required number of openable tubes and required space (width) dimensions

Determine the cable/tube arrangement and required number of openable tubes. After they have been determined, check the required space (width).

Reference information

Page	Item
5	Number of cables (jackets) and tubes to be installed and recommended materials
6	Installation dimensions

Example:

Installation cables

No.	Cable outer diameter mm	With/without shield	Quantity	Mass kg/m
(1)	6.6	Shielded	1	0.052
(2)	7.1	Shielded	1	0.070
(3)	7.2	Shielded	1	0.073

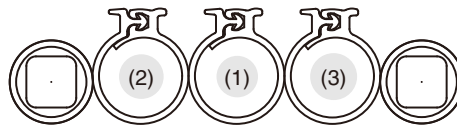

Required number of openable tubes
3

Required space (Width)
186 mm

Step 2 Determination of support member bending radius

Determine the support member bending radius based on the allowable bending radius of the cable/tube to be installed.

Reference information

Page	Item
5	Basic specifications

Allowable bending radius of cable/tube

Check the allowable bending radius recommended by the cable/tube manufacturer (for repeated bending).

Refer to the following guideline.

- Cable with shield = Max. cable outer diameter × 8
- Cable without shield = Max. cable outer diameter × 6
- Tube = Max. tube outer diameter × 9

Determination of support member bending radius

Select a support member bending radius greater than the allowable bending radius of the cable/tube.

Allowable bending radius of cable/tube



Support member bending radius

Example:

Installation cables

No.	Cable outer diameter mm	With/without shield	Quantity	Mass kg/m
(1)	6.6	Shielded	1	0.052
(2)	7.1	Shielded	1	0.070
(3)	7.2	Shielded	1	0.073

Cable allowable bending radius = 7.2×8
= 57.6 mm

Select a support member bending radius greater than 57.6 mm.

Support member bending radius
R070

Step 3 Check of capability with a load diagram

Using the load diagram that shows the required number of openable tubes and the support member bending radius, check that the operating conditions (travel length, cable/tube mass) are within the capability range.

Reference information

Page	Item
11 to 12	Load Diagram

Example:

Installation cables

No.	Cable outer diameter mm	With/without shield	Quantity	Mass kg/m
(1)	6.6	Shielded	1	0.052
(2)	7.1	Shielded	1	0.070
(3)	7.2	Shielded	1	0.073

Operating conditions:

- Travel length: 0.6 m
- Cable mass per meter: 0.195 kg/m

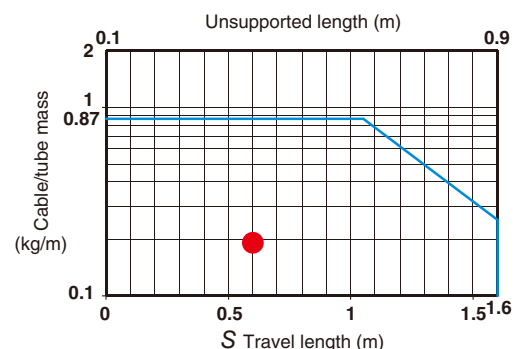

Step 4 Check of installation dimensions

Check the space required for installation.

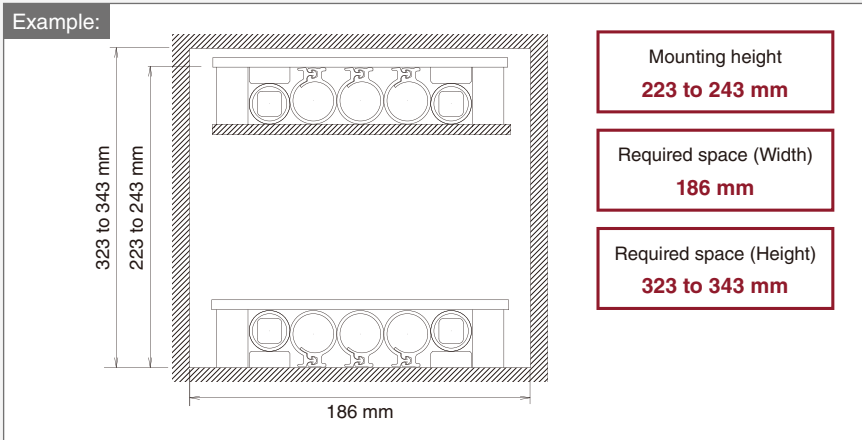

Reference information

Page	Item
6	Installation dimensions

Step 5 Calculation of the number of support member links

Reference information

Page	Item
5	Basic specifications
6	Fixing parts and installation dimensions

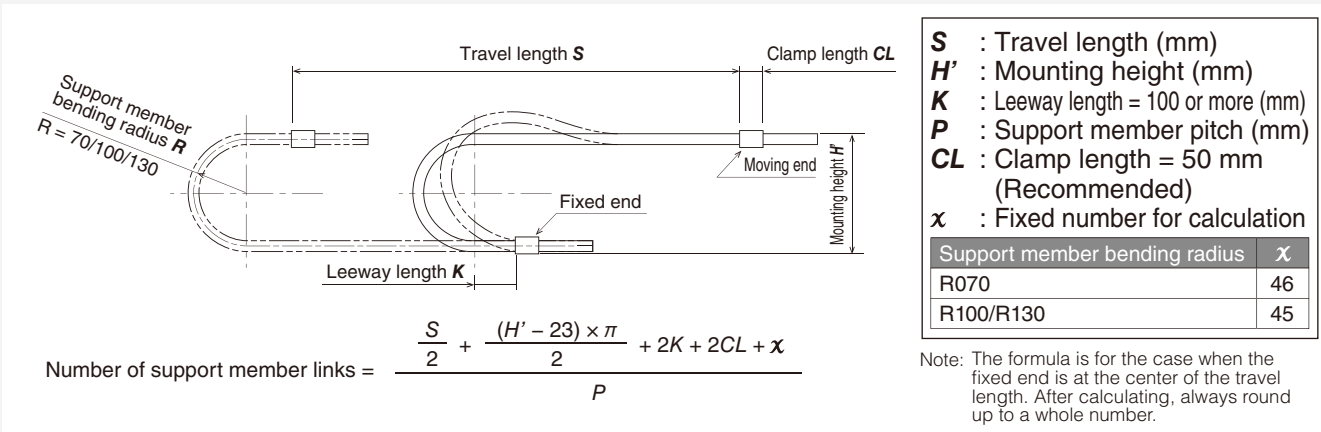

Example:

In case of $S = 600$, $H' = 233$, support member bending radius R070

$$\begin{aligned} \text{Number of support member links} &= \frac{600}{2} + \frac{(233 - 23) \times \pi}{2} + (2 \times 100) + (2 \times 50) + 46 \\ &= 48.7933... \\ &= 49 \end{aligned}$$

Number of links
49 links

Step 6 Determination of color

Determine the color of the product.



Load Diagram

The load diagrams for each support member bending radius are classified by the number of openable tubes.

Support member bending radius 70 mm (R070)

1 openable tube

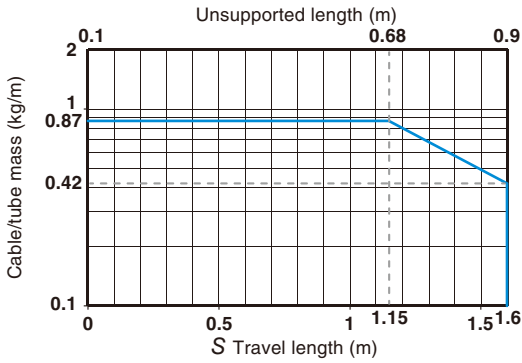

2 openable tubes

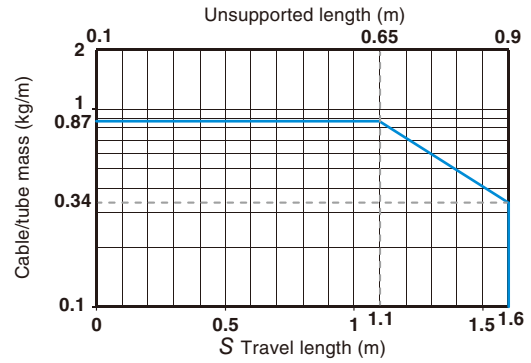

3 openable tubes

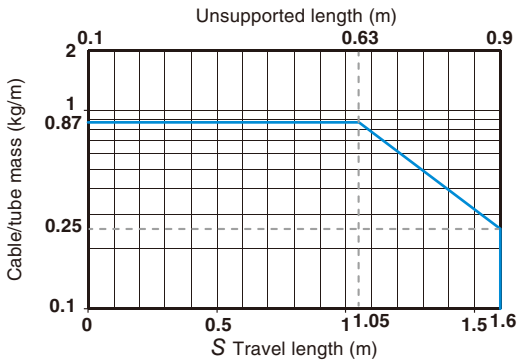

4 openable tubes

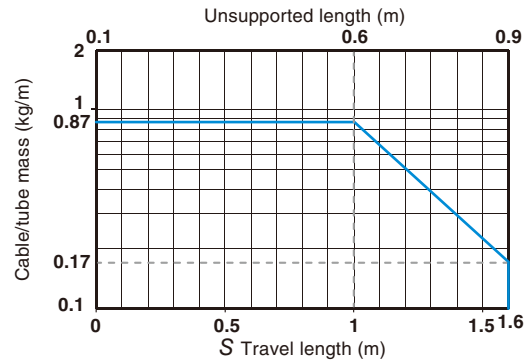

5 openable tubes

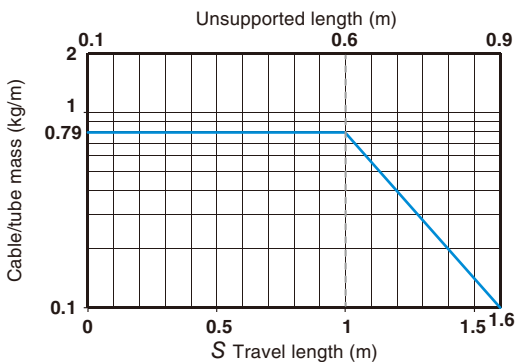

6 openable tubes

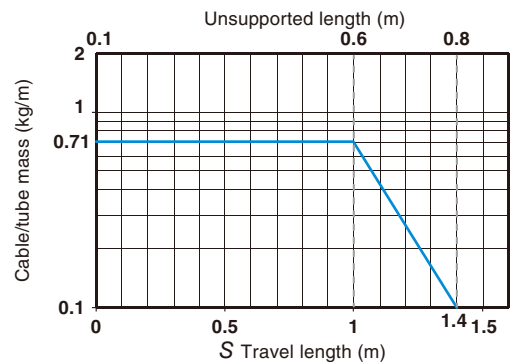

7 openable tubes

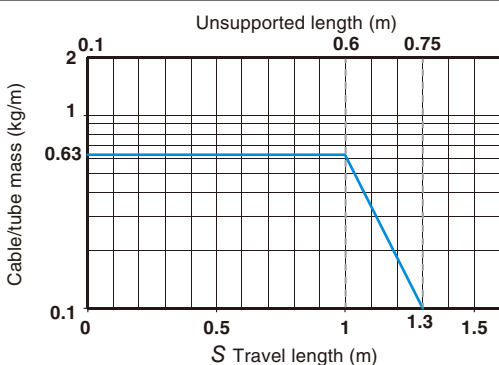

8 openable tubes

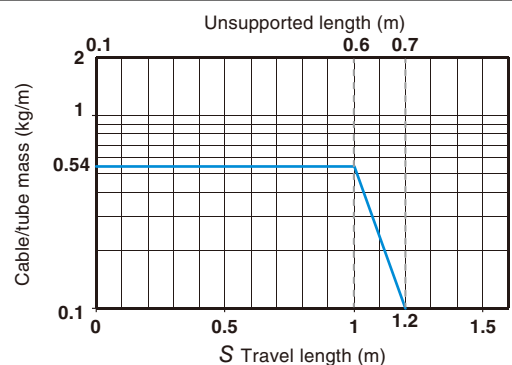

Support member bending radius 100 mm (R100)/130 mm (R130)

The same load diagrams are used for 100 mm (R100) and 130 mm (R130).

1 openable tube

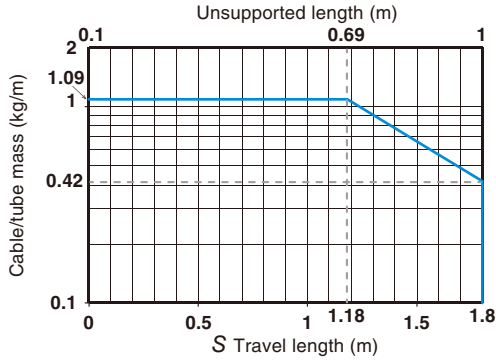

2 openable tubes

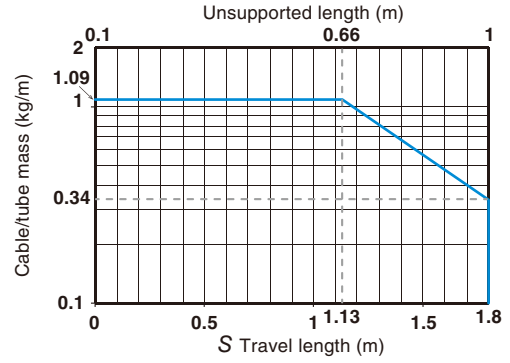

3 openable tubes

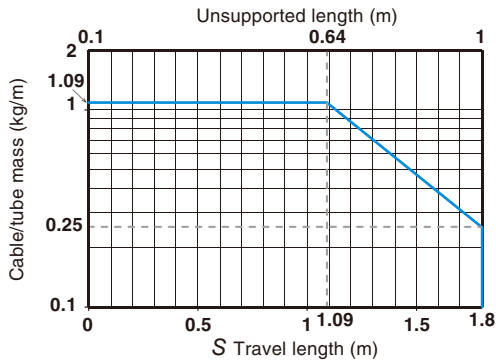

4 openable tubes

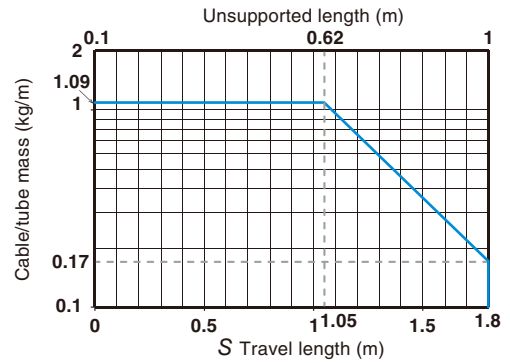

5 openable tubes

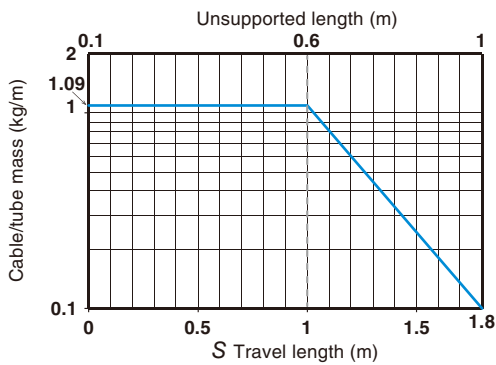

6 openable tubes

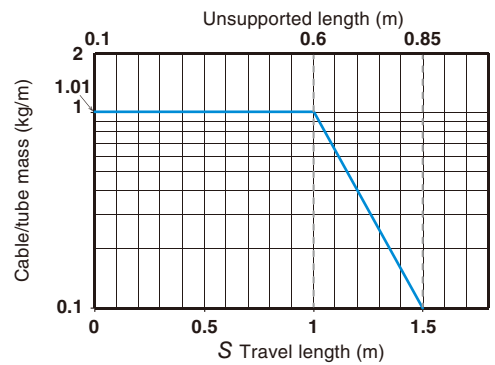

7 openable tubes

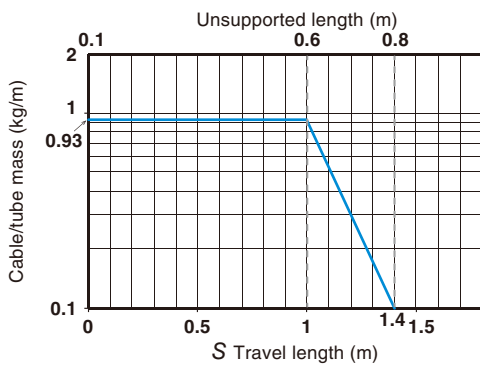

8 openable tubes

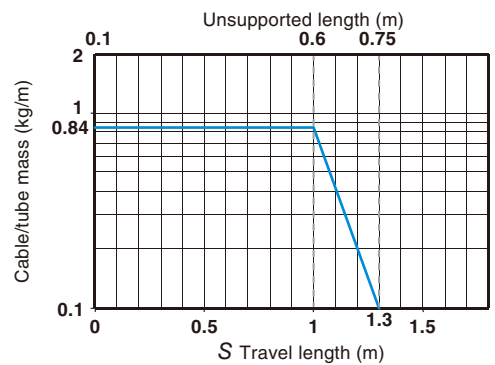

Handling Instructions

Cable/tube installation procedure and locking part opening and closing procedure

1



Open the locking part from the end of the openable tube.

2



Install the cable or tube inside the openable tube.

3

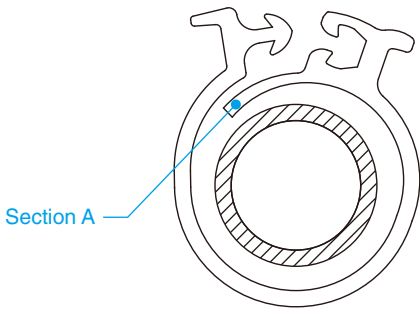

Make sure that section A is correctly overlapped around the entire length of the Flatveyor as shown in the figure above.

4



Temporarily tighten the end of the openable tube by hand.

5



Close the locking part from the end of the openable tube using the closing tool. (Also closable by hand)

6

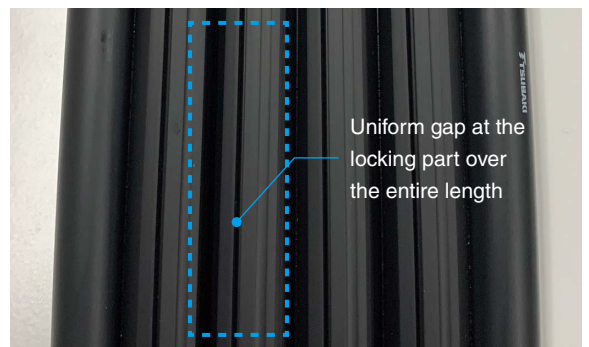

Check that the locking part is properly closed. Refer to figure 7 on page 16.

Procedure for installation on equipment

1



After inserting the cable/tube and before mounting it on the equipment, the locking part of the openable tube should be facing outward, and the Flatveyor should be bent as shown in the figure above.

2



Fix the fixed end and the moving end to the equipment using clamps in the state shown in 1.

3

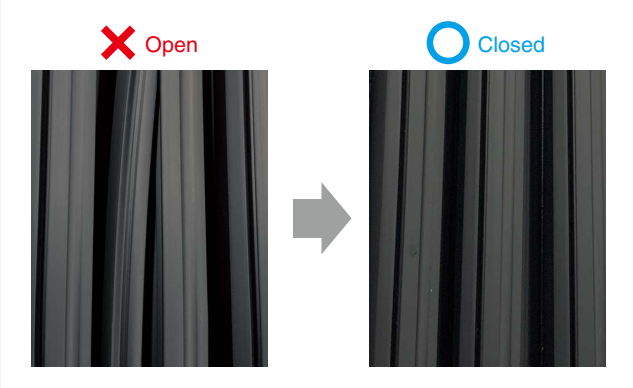

Ensure that the locking part of the openable tube is properly closed.

4



Check that the bending section of the Flatveyor is not tilted and that the unsupported length is not twisted.

5

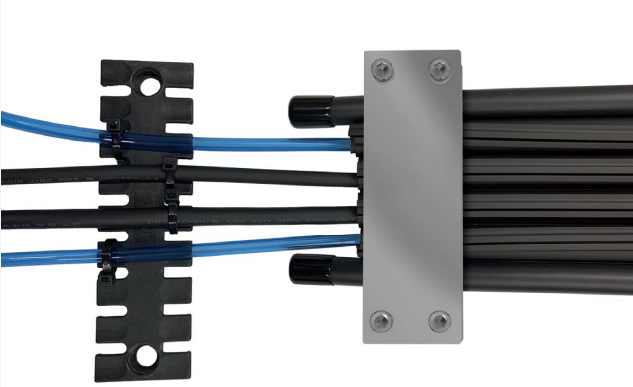

Fix each cable/tube at both the fixed end and the moving end using a cable tie or similar implements.

6

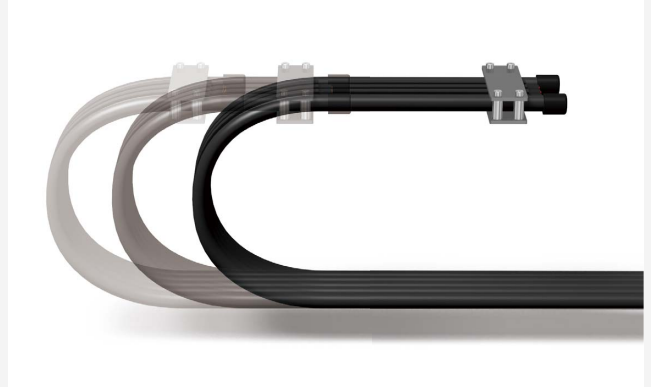

Move the Flatveyor slowly to ensure that each cable/tube is not pulled into the openable tube. Check that there are no other operation abnormalities.

Precautions for handling

1



- Please handle the cables and tubes with care when wiring and mounting them in equipment to ensure that forces are not applied in a tearing direction on the welded ends. If a force in the tearing direction is applied to a welded end, it could cause the welded section to peel off.

3

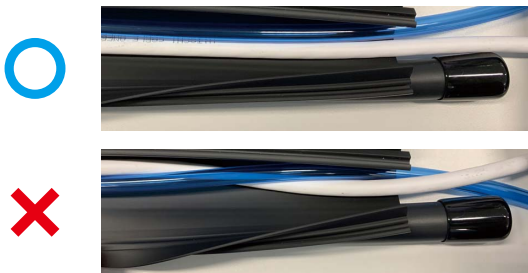

- When installing multiple cables or tubes in a single openable tube, install by keeping the cables or tubes aligned. Installing cables while they are twisted could cause premature breakage due to entanglement of cables in the openable tube.

5



- Do not fix cables or tubes inside the openable tubes using cable ties or similar implements. Doing so could cause the openable tube to tear.

2

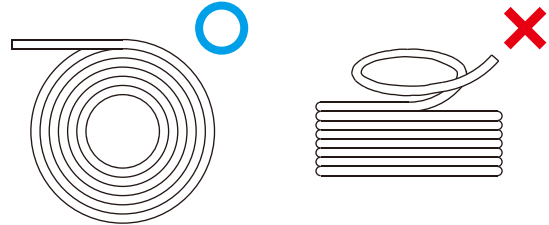

- Cables and tubes should be routed without twisting. Do not pull out from the drum or coil in a spiral pattern because this will cause the cable or tube to be routed with a twist. The cable winding tendency may cause the Flatveyor to tilt at angle.

4

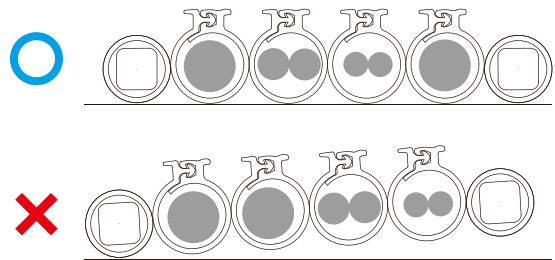

- For installation of cables and tubes, ensure that the cable weight is symmetrically distributed across the width of the Flatveyor.

6

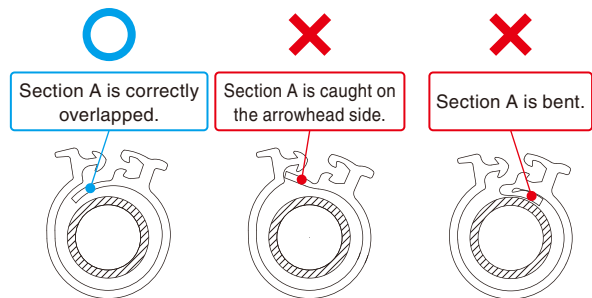

- Make sure that section A of the locking part is correctly overlapped. If not correctly overlapped, the locking part could open.

7

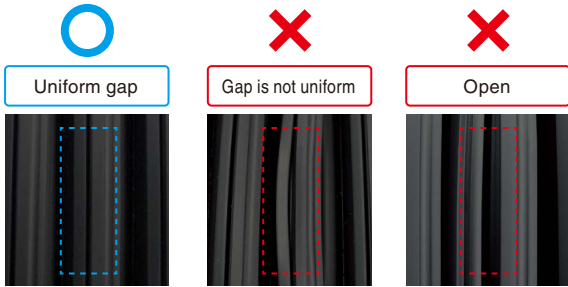

- If the gap between the locking part is not uniform or if a locking part opens, section A may not be overlapped correctly.

8

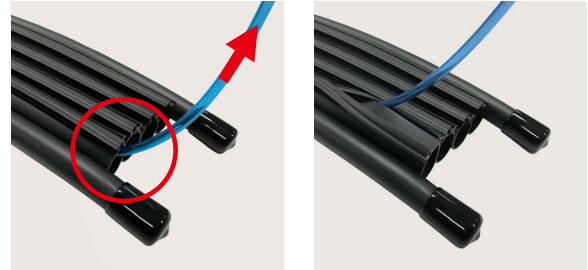

- After closing the locking part, ensure that the cable or tube does not exert any outward force on the locking part end. Otherwise, the locking part could open.

9

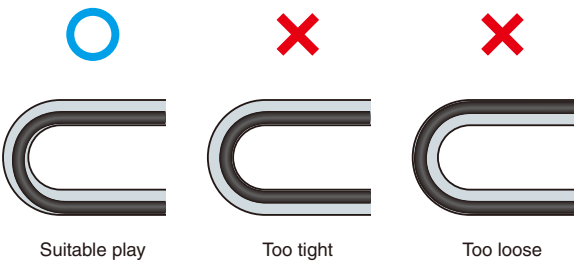

- When fixing cables and tubes, make sure to provide a suitable amount of play. Otherwise, the openable tube could tear or the locking part could open.

10

Caution

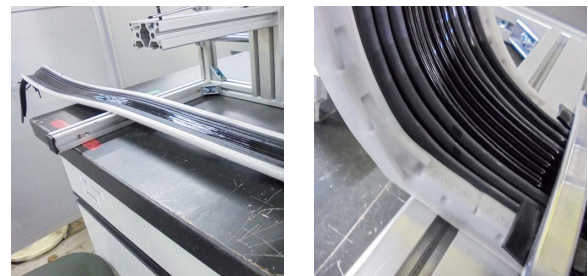

- Make sure to fix to the equipment in a bent position with the locking part facing outward. Fixing one end (fixed or moving end) to the equipment while the Flatveyor is extended could cause the support member to be fixed in a direction other than the bending direction. Bending in this state could damage the support member.

11



- Do not install any object that could interfere with the inner circumference of the Flatveyor.

Notes when replacing cable/tube

- When replacing cables and tubes, remove the Flatveyor from the equipment, and perform the replacement work outside the equipment.
- Blow air into the openable tube to clean it before replacing.

Periodic inspection points

Periodically perform inspection for the following points. If any abnormality is found during inspection, maintenance should be performed.

- Locking part of openable tube is not open.
- No objects on the floor surface that could damage the Flatveyor.
- Cables and tubes are not being pulled into the openable tube.

Service life

(1) Unsupported length sag limits (guideline)

The product is considered to have reached the end of its service life when the smaller of the following is reached.

- 1) 10% of unsupported length
- 2) Support member bending radius (R)

Example:

Unsupported length: 500 mm → (1) 50 mm (500 mm × 10%)
Support member bending radius: R070 → (2) 70 mm } Sag amount limit (guideline): 50 mm

(2) Flatveyor damaged due to age-related deterioration, etc.

The following abnormal conditions may also occur as Flatveyors deteriorate over time.

- Tearing of openable tube
- Breakage of support member
- Peeling of welded parts, etc.

Notes when storing or replacing cables and tubes

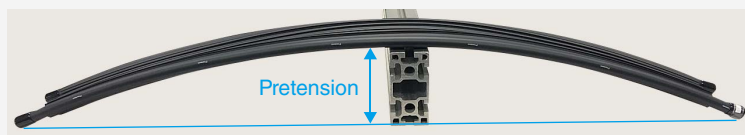

To make the work easier, refer to the following when opening or closing openable tubes and when storing or replacing cables and tubes.

- Lift the product in the middle as shown in the figure above using a stand or other equipment with no corners, burrs, or other characteristics that may damage the product.
- Use a stand with a height appropriate for the pretension of the product.
(The pretension will vary depending on the product length, the number of openable tubes, and the support member bending radius.)

Safety Precautions

⚠ WARNING To prevent hazards, be sure to observe the following safety precautions.

- Do not use the cable carrier (including Cleanveyor and Flatveyor) or its parts for anything other than their original purpose.
- Do not stand or ride on the cable carrier. There is a risk of damage and falls.
- Never attempt to make additions or modifications to the cable carrier or its parts. (except for Cleanveyor and Flatveyor cable and tube end terminations)
 - Do not clean cable carriers or their parts with acid or alkali. Doing so will cause cracks to form.
 - Never electroplate the cable carrier or its parts. Doing so could cause hydrogen embrittlement cracking.
 - Do not weld onto the cable carrier or its parts. Doing so will cause loss of strength and cracking due to thermal effects.
- Observe the general standards stipulated in Part 2, Chapter 1, Section 1 of the Ordinance on Industrial Safety and Health. (The Ordinance on Industrial Safety and Health also includes items that do not apply to cable carrier products.)
- When replacing worn (damaged) parts, do not replace only the worn (damaged) parts, but replace all parts with new ones.
- If any substance (acid, strong alkali, battery acid, etc.) that may cause embrittlement cracking adheres to the cable carrier or its parts, immediately stop using the cable carrier or its parts, and replace them with new ones.
- Be sure to observe the following points when connecting, mounting, disconnecting, and servicing cable carriers and its parts.
 - Perform the procedures as specified in the instruction manual, catalog, or documentation specially provided to the customer.
 - Secure the cable carrier and parts so they do not move freely. Otherwise, the cable carrier may move on its own or collapse under its own weight.
 - Be careful that your hands do not get pinched, crushed, or entangled in the bending section of the cable carrier.
 - Wear suitable clothing and protective equipment for the work (such as safety goggles, gloves and safety shoes).
 - Always turn off the main power supply of the equipment before starting any work, and be careful not to inadvertently operate any switches.
 - Only experienced personnel should handle the cable carrier.

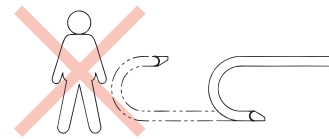
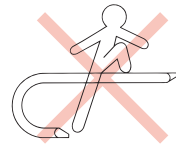

⚠ CAUTION Observe the following points to prevent accidents.

- Be sure that you fully understand the construction and specifications of the cable carrier and its parts before operation.
- Before installing, inspect the cable carrier and its parts for any damage that may have occurred during transport.
- The cable carrier and its parts should be periodically serviced and inspected.
- The performance of the hose and cable carrier system varies depending on the manufacturer. Please be sure to use a Tsubaki product when selecting based on the Tsubaki catalog.
- Be sure to give the instruction manual to the end user.
 - If no instruction manual is available, use the product name, series name, and model number to request an instruction manual from the distributor where the product was purchased or from Tsubaki.
- The product details described in this catalog are intended primarily for model selection. Before using the product, read the instruction manual thoroughly, and ensure the product is used correctly.

Warranty

1. Warranty period without charge

Tsubakimoto Chain Co. (hereinafter referred to as "Company") provides a warranty without charge valid for either 18 months after the shipment of the purchased product (hereinafter referred to as "Goods") from the factory, or 12 months after the first use of Goods, whichever comes first. First use of Goods is considered to be the complete incorporation of Goods into the equipment of the purchasing party (hereinafter referred to as "Customer"). This warranty may be provided with charge in certain circumstances.

2. Warranty coverage

Should any malfunction in Goods arise during the warranty period, given that Goods were properly installed, operated, and maintained as instructed in the catalog, instruction manual, or similar, Company shall promptly deliver or repair Goods at no charge once Company has confirmed such failure. This warranty covers delivered Goods only and therefore does not include the following: ("Instruction manual or similar" includes documentation specially provided to Customer.)

- (1) Any costs required for the removal or installing of Goods from or into Customer's equipment for repair or replacement.
- (2) Costs required for transporting Customer's equipment to repair shop, etc.
- (3) Profits lost due to a malfunction or repair, or any other consequential loss.

3. Warranty with charge

Company will charge for any investigation, repair, and/or manufacturing of a malfunction in Goods (even during the warranty period) if caused by:

- (1) Improper location, installation (including cutting and connecting), lubrication, or maintenance by the Customer failing to follow the catalog, instruction manual, or similar. ("Instruction manual or similar" includes documentation specially provided to Customer.)
- (2) Operation methods (including operating conditions, operating environment, and allowable values) resulting from Customer's failure to follow operation described in the catalog, instruction manual, or similar. ("Instruction manual or similar" includes documentation specially provided to Customer.)
- (3) Inappropriate disassembly, modification, alteration, or processing by Customer.
- (4) Use of Goods by Customer in conjunction with damaged or worn parts not made by Company. (Ex: Use of Goods with sprocket, drum, rail, etc., that has a worn chain.)
- (5) When the service life of Goods determined by Company under Customer's operating conditions does not satisfy the warranty service life.
- (6) Use by Customer under conditions other than those discussed.
- (7) Consumption, wear, or deterioration of bearings, oil seals, oil, and other consumable parts incorporated into Goods.
- (8) Secondary failure or malfunction in Goods resulting from malfunctioning of Customer's equipment.
- (9) Malfunction of Goods resulting from a Force Majeure such as an act of God.
- (10) Malfunction of Goods resulting from a wrongful act committed by a third party.
- (11) Any other reason that is not attributable to Company.

The logos, brand names, or product names in this catalog are trademarks or registered trademarks of Tsubakimoto Chain Co. and/or its subsidiaries and/or affiliates in Japan and/or other countries.

* The specifications in this catalog are subject to change without notice for incorporating improvements or other reasons. Please contact us or check our website to ensure that you have the latest information before designing.



TSUBAKIMOTO CHAIN CO.

Japan Tsubakimoto Chain Co. <https://tsubakimoto.com/>

Global Group Companies

AMERICAS

United States U.S. Tsubaki Power Transmission, LLC <https://www.ustsubaki.com/>
Brazil Tsubaki Brasil Equipamentos Industriais Ltda. <https://tsubaki.ind.br/>
Canada Tsubaki of Canada Limited <https://tsubaki.ca/>

EUROPE

Netherlands Tsubakimoto Europe B.V. <https://tsubaki.eu/>
France Kabelschlepp France S.A.R.L. <https://tsubaki-kabelschlepp.com/fr-fr/>
Germany Tsubaki Deutschland GmbH <https://tsubaki.de/>
Tsubaki Kabelschlepp GmbH <https://tsubaki-kabelschlepp.com/de-de/>
Italy Kabelschlepp Italia S.R.L. <https://tsubaki-kabelschlepp.com/it-it/>
Spain Tsubaki Ibérica Power Transmission S.L. <https://tsubaki.es/>
United Kingdom Tsubakimoto UK Ltd. <https://tsubaki.eu/>
Slovakia Kabelschlepp-Systemtechnik, spol. s.r.o. <https://tsubaki-kabelschlepp.com/sk-sk/>
Poland Kabelschlepp Sp. z o.o. <https://kabelschlepp.pl/>

INDIAN OCEAN RIM

Singapore Tsubakimoto Singapore Pte. Ltd. <https://tsubaki.sg/>
Australia Tsubaki Australia Pty. Limited <https://tsubaki.com.au/>
India Tsubaki India Power Transmission Private Limited <https://en.tsubaki.in/>
Indonesia PT. Tsubaki Indonesia Trading <https://tsubaki.id/>
Malaysia Tsubaki Power Transmission (Malaysia) Sdn. Bhd. <https://en.tsubaki.my/>
New Zealand Tsubaki Australia Pty. Limited - New Zealand Branch <https://tsubaki.com.au/>
Philippines Tsubakimoto Philippines Corporation <https://en.tsubaki.ph/>
Thailand Tsubakimoto (Thailand) Co., Ltd. <https://tsubaki.co.th/>
Vietnam Tsubakimoto Vietnam Co., Ltd. <https://tsubaki.net.vn/>

EAST ASIA

Republic of Korea Tsubakimoto Korea Co., Ltd. <https://tsubakimoto-tck.co.kr/>
Taiwan Taiwan Tsubakimoto Trading Co., Ltd. <https://tsubakimoto.tw/>

CHINA

China Tsubakimoto Chain (Shanghai) Co., Ltd. <https://www.tsubaki-sh.cn/>



The Tsubaki Eco Link logo is used only on products that satisfy the standards for environmental friendliness set by the Tsubaki Group.